

INSTALLATION AND OPERATOR'S MANUAL

Balmar's Smartgauge™ battery monitoring system provides accurate dependable information about battery condition, without the need for shunts and complicated programming. Simply select the battery program that most closely matches your battery technology.

The Smartgauge™ features Voltage and State of Charge (SoC%) displays, and can be used to provide alarms for low battery voltage and capacity.

As with all electrical components, take time to read and follow the instructions provided in this manual. Failure to do so could result in damage to the Smartgauge™ and/or your electrical system.



CONTENTS

SECTION	TOPIC	PAGE
1.0	Introduction	Page 2
2.0	Quick Start Guide	Page 3
2.1	Smartgauge Installation Basics	Page 5
2.2	Important Installation Notes.....	Page 5
3.0	Initial Smartgauge Start Up	Page 6
3.1	Determining Battery Charge Status.....	Page 6
3.2	Calibrating Battery Charge Status.....	Page 7
3.3	Power Up After Power Loss	Page 7
4.0	Basic Monitor Use	Page 8
4.1	Set Up Menu.....	Page 9
4.2	Set Up Mode – Battery Type	Page 9
4.3	Set Up Mode – Charge Status	Page 10
4.4	Alarm Functions	Page 10
4.5	Defeating Error Codes	Page 13
4.6	Set Up Display Behavior.....	Page 14
4.7	Set Up Display Brightness	Page 14
4.8	Set Up Menu Lock	Page 15
5.0	Error Codes.....	Page 15
6.0	Reset to Factory Defaults	Page 16
7.0	Alarm Outputs	Page 17
8.0	Alarm Notes	Page 17
9.0	Addendum.....	Page 17
10.0	Specifications	Page 18
11.0	Warranty	Page 19
12.0	Smartgauge Display Flowcharts.....	Page 19

The Smartgauge™ battery monitor employs advanced battery monitoring techniques to provide battery voltage and State of Charge (SoC%) information in a manner that's both highly accurate and self correcting. Smartgauge™ is unconventional – please read this manual fully to understand how and why it works.

Further technical support can be obtained from Balmar Customer Service at +1-360-435-6100.

Features:

- House (Primary) Battery Voltage
- House (Primary) Battery State of Charge
- Engine (Secondary) Battery Voltage
- High/Low Battery Voltage alarms for each battery
- High/Low State of Charge alarm for House (Primary) battery
- Bright LED daylight readable display
- Volt free alarm contact for firing external alarms, relays etc

How the Smartgauge™ Works

Conventional battery monitors count amp hours in/out of the battery to determine the battery's State of Charge (SoC). This method is inherently inaccurate due to the State of Charge of the battery not necessarily being linked to the amount of energy a battery can deliver (due to temperature, how quickly the battery was charged/discharged, battery age, and other outside factors). Unless the battery monitor is regularly reset (either automatically by fully charging the battery or manually reset by the user), the reading error will compound (known as synchronization error).

In most battery monitors, a shunt is used to monitor amperage in or out of the battery. Unfortunately, in many cases shunts can be incorrectly installed, and inaccurate amperage readings occur.

Smartgauge™ uses just two wires to monitor the battery. Through these wires, we use proprietary test methods to generate data. This data is then compared to detailed computerized battery models. Smartgauge™ compares real world data with those models to generate information on the battery's State of Charge. In independent testing Smartgauge™ was found to be within 5% accuracy at all times.

Highly accurate SoC information not only allows you to confidently make decisions about how you use your electrical system, it also allows you to automate certain functions – like load shedding or generator start/stop.

Smartgauge™ uses a self correcting algorithm to determine battery State of Charge, so over time it actually becomes more and more accurate. This self correction also means that Smartgauge™ automatically adjusts for battery degradation as the batteries are repeatedly cycled. Smartgauge™ needs to see 2-3 charge/discharge cycles to synchronize with the batteries.

CAUTIONS AND WARNINGS

CAUTION: Statements Identified with the word CAUTION relate to practices that may damage Smartgauge

WARNING: Statements identified with the word WARNING relate to practices that may cause injury or death.

CAUTION & WARNING: This manual is written with the intention for use by a qualified electrical technician. It does not identify normal practices or procedures that would be expected of a qualified electrician. Please review and comply with any installation and/or safety standards, such as those provided by ABYC or other agencies regulating electrical system safety. Please review the instruction manuals for any equipment or tools that you may be using to complete this installation.

CAUTION: Please fully review this manual before commencing installation.

Certificate of Conformity:



Declaration of Conformity



Smartgauge™ is in compliance with the requirements of EU Electromagnetic Compatibility (EMC) Directive 89/336/EEC. Smartgauge™ complies with RoHS (Reduction of Hazardous Substances) Directive 2002/95/EC. Smartgauge™ contains no Lead. At the end of life, Smartgauge™ should be disposed of as normal electrical waste.

SECTION 2.0 – QUICK START GUIDE

CAUTION & WARNING:

Batteries are hazardous items. Please follow battery manufacturer's recommendations for health and safety. Use only the appropriate tools in conjunction with manufacturer's instructions. Isolate both battery and AC power supplies before attempting installation.

CAUTION & WARNING:

The Quick Start Guide does not refer to each and every Caution & Warning Statement in this manual. Be sure to observe safe working practices at all times. Refer to the full manual if you are unsure of any practices that may damage the Smartgauge™ unit, your system wiring or health.

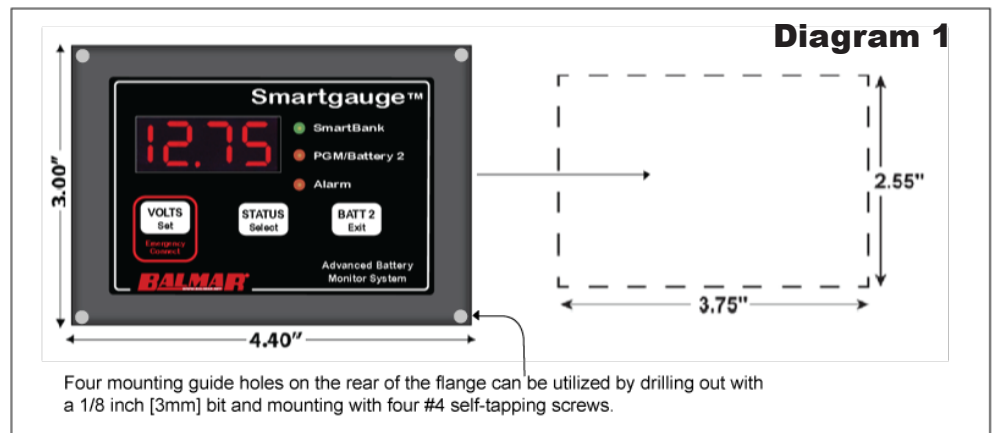

The Quick Start section of this guide assumes Smartgauge™ is being installed for the first time. If this is not the case, please refer to the main section of this manual as the power up sequence will be different.

The Smartgauge™ display panel is typically mounted at the dash or navigation area, or in other locations where it can be easily accessed for viewing. The rectangular display panel requires a rough opening measuring 3.75" wide by 2.55" tall, as illustrated in Diagram 1. The overall dimensions are 4.40" wide by 3.00" tall. The panel depth is 1". Access to the rear of the monitor is necessary for the installation of ground and positive sense wires from the monitor directly to the battery banks. In addition, there are terminals for wiring connections to install separate wires for an audible or visual low-voltage/low-battery capacity alarm. Four cutout dimples can be found on the back of the mounting flange of the monitor's display if mounting screws are desired.

Once a location has been determined for the monitor panel, sensing and ground wires can be run to the batteries, as described in Diagram 2 on the following page.

The Smartgauge™ does not require a separate shunt for installation. Battery voltage and State of Charge are both determined via sense wires connected directly to the positive terminals of one or both battery banks. To install:

1. Run a 18 AWG ground wire from the GND terminal on back of the Smartgauge™ to the battery negative post of the house battery bank.
2. Run a 18 AWG positive sense wire from the B1 terminal on Smartgauge™ to the battery positive post of the house battery bank. This wire must be fused at 3 amps with the fuse holder installed as close to the battery as possible – note that the fuse should be outside any battery compartment where battery gases may accumulate. It should not be run to bus-bars, isolation switches, fuse panels etc.
3. If a second battery is to be monitored for voltage, run an additional 18 gauge (AWG) wire, fused at 3 amps, from the B2 terminal on Smartgauge™ to the positive battery post of the second battery bank. Again, this fuse should be located as close to the battery as possible (but not inside the battery compartment if combustible gases can build up).

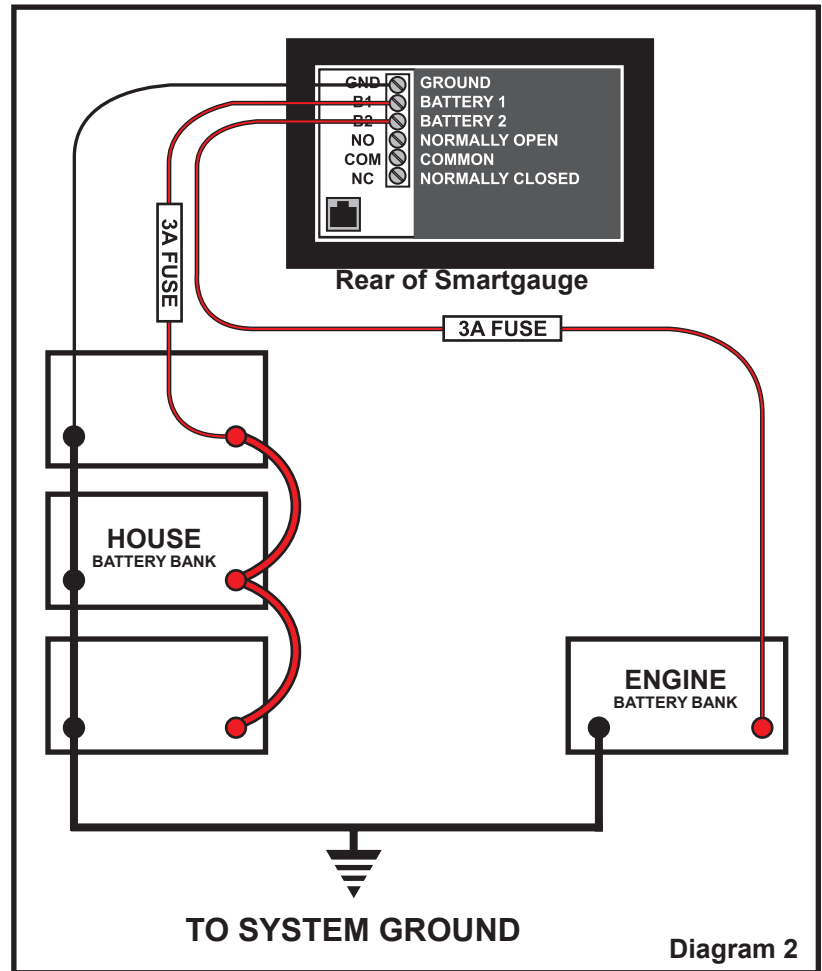

Once the ground and positive sense wires are connected, the monitor display will indicate the software and battery model revisions. The Smartgauge™ will then show “bt 1” in the display and the PGM/Batt 2 LED will be flashing. Use the STATUS button to scroll through the program choices, as listed below:

Number	Battery type
1	Deep-cycle flooded lead acid (Examples: Trojan, US Battery, Rolls, Interstate, Exide, Deka/East Penn, Dyno, Crown, Superior)
2	Gel Cell (Examples: Deka/East Penn GEL, Sonnenschein Prevalier GEL)
3	AGM – Absorbed Glass Mat (Examples: Lifeline AGM, Firefly AGM, Deka/East Penn AGM, US Battery AGM, Rolls AGM, Optima AGM)
4	Dual-purpose lead acid
5	Carbon fiber lead acid
6	Sealed, maintenance-free lead acid

****NOTE:** There are two distinct types of AGM battery. The first are similar to standard lead/acid with the addition of a glass matt separator. The second have this glass mat separator but also additional chemicals added. The first type have similar charging voltages to Deep Cycle Lead/Acid (14.6V/29.2V max) – in this instance Smartgauge™ should be set to Battery Type 1. Examples include AGM TPPL batteries such as Odyssey TPPL and Northstar TPPL batteries. The second type have lower charging voltages (similar to Gel) at around (14.0-14.2V/28.0-28.4V) max – in this instance Smartgauge™ should be set to Battery Type 3.

When the desired battery type number is shown, press VOLTS (set) or BATT 2 (exit). The display will show house battery voltage. Pressing BATT 2 will display the voltage on the engine battery and the PGM/Batt 2 LED will be lit.

Pressing the STATUS button will display the charge status as a percentage. Initially, battery charge status will be shown at 75%. During the first run cycle, the Smartgauge™ will begin to synchronize itself. It will typically take two or three discharge and recharge cycles for the Smartgauge™ to “learn” to accurately read your house battery’s State of Charge. Synchronization is not an instant effect. The Smartgauge™ will continue to track battery condition with increasing accuracy over time.

This completes installation and initial setup of Smartgauge™. For operation and details of further functions such as alarms, error codes, etc., refer to the main section of the owner’s manual.

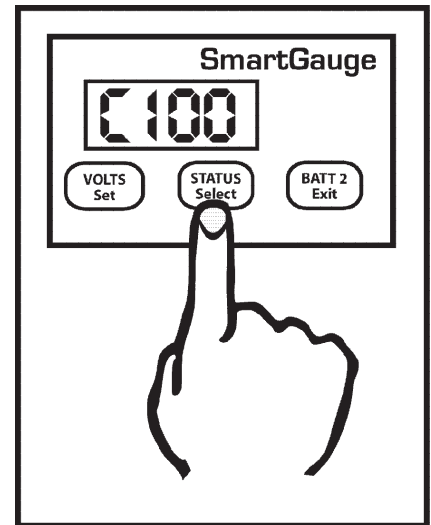

SECTION 2.1 – Smartgauge INSTALLATION BASICS

The purpose of this manual is to enable the installer to install Smartgauge™ in a manner that permits it to operate as designed. This manual’s purpose is not to educate the installer on the legal requirements of any particular type of installation. The manufacturer, supplier, dealer and/or their agents cannot know what the final installation will be and therefore cannot know what the legal requirements of such installation may be.

Installation of Smartgauge™ is simple and should be completed in a short time. Only two wires are required to operate Smartgauge™ for normal single-bank system, with only three wires required for a dual-bank installation.

SECTION 2.2 – IMPORTANT INSTALLATION NOTES

1. The sense wire connected to the B1 terminal on the back of the Smartgauge™ must be connected to the house (primary) battery bank. The B2 terminal should be connected to the engine starting battery via the secondary sense wire.
2. Both battery banks must be either 12 volts or 24 volts. The Smartgauge™ cannot be used in a mixed installation with 12-volt and 24-volt battery banks.
3. Battery banks connected to the Smartgauge™ MUST share a common ground. It is not possible to install the Smartgauge on 2 isolated battery systems or on 2 battery systems with a common positive.
4. Keep wire runs between the Smartgauge™ and the batteries as short as possible. Use at least 16-gauge (AWG) wire for B1 sense, B2 sense and Negative (Ground) connections.
5. B1 and B2 sense wires must be fused as near to the batteries as possible. A 3-amp ATC fuse is recommended for each sense wire installed.
6. Positive voltage sense and negative (ground) wires must be connected directly to the battery posts of the batteries being monitored. Connecting them to busses or other non-battery terminal connections could result in poor or inaccurate monitor performance.
7. Do not use positive sense wires or ground wires as power sources for other loads (like warning lights or audible alarms). Doing so will affect Smartgauge™ accuracy.
8. If Smartgauge™ is replacing a shunt-based monitor or ammeter, do not connect the sense wires to the existing shunt. The sense wires MUST be connected directly to the batteries being monitored.

OFF = No SmartBank Connected
 Fast Flash = SmartBank Standby
 Slow Flash = SmartBank High Voltage Disconnect

ON = Battery 2 Voltage Displayed
 Flashing = Programming Mode

ON = Alarm Triggered

Display Battery 2 Volts
 (Engine Battery)

Display Battery 1
 (House Battery Bank)
 Status (State of Charge)

Display Battery 1
 (House Battery Bank)
 Volts

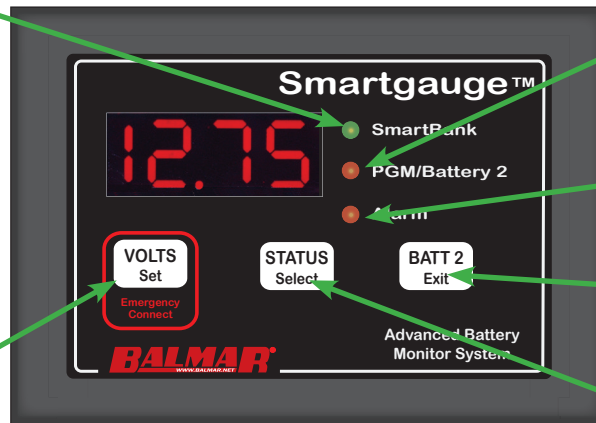

On powering up Smartgauge™ for the first time, the display will show the software revision information. The following are just examples. They are required for troubleshooting.

r1.03 = Software revision 1.03
 b1.05 = Battery model revision 1.05

Smartgauge™ will then display “SC” indicating that it’s determining system battery voltage. Depending on the system voltage detected during the system check, the Smartgauge™ will display “SC12” or “SC24”. Refer to the chart at the end of this manual headed “12.1 – First time power up or following factory reset” for specifics.

The next display will indicate “bt 1”. This is your opportunity to select the battery type. Refer to Section 4.2, headed “Battery types”, for further details. Pressing the STATUS button will scroll through the available battery types. Pressing the VOLTS button will store the battery program you select based on your battery type. The display will flash four times to signify the data has been written to computer memory. The display will then show the current battery voltage.

That completes the installation and initial set-up.

SECTION 3.1 – DETERMINING BATTERY CHARGE STATUS

Once the Smartgauge™ has completed its initial start-up routine, you can determine the charge status of the primary (house) battery bank by pressing the STATUS button. The charge status will be displayed as a percentage. During the first operation, the monitor will display “C 75”, indicating 75 percent charge. As the Smartgauge™ goes through its first charge cycle, it will begin to “learn” the actual condition of the batteries, and it will more accurate during subsequent periods of operation. If you know the actual level of charge, you also have the option to manually set the charge status. See page 7 for multiple methods for calibrating the monitor to ensure accuracy.

To revert to the Battery Voltage, press the VOLTS button. Pressing the BATT 2 button will show the voltage on Battery 2 if the Smartgauge has been wired to both house and starting batteries. The PGM/Batt 2 LED will be lit whenever voltage at the starting battery is being displayed.

To revert to the voltage or charge status of the house battery bank, press the VOLTS button or the STATUS button.

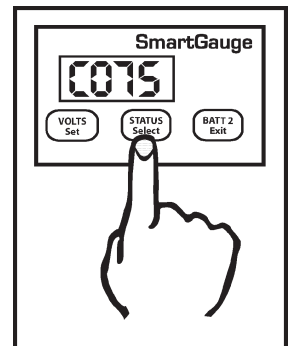

Initially Smartgauge™ defaults to an SoC of 75%. There are 4 very simple ways this can be corrected:

1. If you know what the State of Charge is (for instance you may know the batteries to be fully charged) you can enter the set-up menu and manually set the charge status to what you know it to be. SoC can be manually set to any value between 0 and 100%. Enter the set-up menu as usual, then press the SET key until “Cxxx” is displayed. Press and hold the SELECT button. The display will scroll from zero to 100. When the desired value is displayed, press the VOLTS button. The display will flash to show the value has been stored. The display will then move onto the next menu item.
2. Charge or discharge the batteries to approach 75%. When the actual State of Charge of the batteries and the displayed charge status meet, Smartgauge™ will be in perfect synchronization with the batteries and will track the charge status from that time onward.
3. Leave Smartgauge™ working for 48 hours. Use the battery system as usual, Smartgauge will automatically catch up over the next 2-3 charge and discharge cycles of the battery bank. Unlike all other battery state of charge meters currently available, Smartgauge™ becomes more accurate the longer it is used. All other battery state of charge meters become less accurate the longer they are used and require multiple recalibrations.
4. The last method is to switch on a charging device and wait until you know the batteries are fully charged (by the charger switching into float charge mode). Then manually set the SoC to 100%.

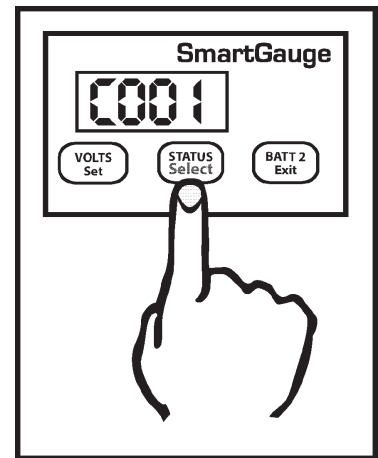
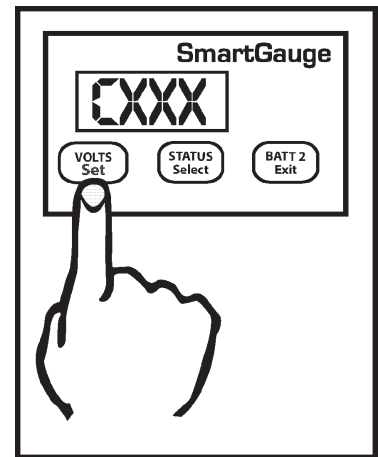

Important Note

On initial power-up, the Smartgauge™ performs a system check to determine whether the system voltage is 12 volt or 24 volt. Smartgauge™ does this by taking eight voltage readings and averaging them. The Smartgauge™ decides whether this measured battery voltage indicates a 12- or 24-volt system. If, at the time of this check, the battery voltage is outside the normal range, the Smartgauge™ may detect the wrong system voltage. This is possible when Smartgauge™ is installed on a 24-volt system with extremely low battery voltage. The low voltage could result in the Smartgauge™ determining that the system is a 12-volt system. Alternately, the Smartgauge™ could be connected to a 12-volt system with a faulty charger that's applying high voltage to the batteries. This would cause Smartgauge™ to incorrectly detect a 24-volt system.

If either of these happen, then Smartgauge™ simply will not operate. Once normal battery voltage is restored, the Smartgauge™ will show a permanent HI or LO reading and an “E04” error. If this happens the solution is to reset the monitor to factory default value, ensure the battery voltage is correct, and re-apply power.

SECTION 3.3 – POWER UP FOLLOWING POWER LOSS

The Smartgauge™ must always be connected to the batteries being monitored in order to operate. It cannot operate and accurately track the State of Charge of the batteries if the sense wire is disconnected from the house battery bank. Should sensing voltage be disrupted, it may be necessary to revert to one of the four methods described in Section 3.2.

When a power failure occurs, the display will alternate between volts and “E01” (error 01 – lost power) until a key is pressed. This is to alert the user to the fact that power has been lost. “E01” will continue to flash until a button is pressed, if another error occurs the new error will not take over, “E01” will remain as the priority error. If the display goes into sleep mode the error will always continue to flash. Again this is to alert the user to a problem.

The “E01” error alerts the user to the fact that power has been lost and therefore the charge status may no longer be accurate. This is the sole reason for this error code. Once a button is pressed the display will move on to show a figure – for example, 2.36 or 17.49 – This is the approximate time in hours and minutes since power was reapplied. It will count up to a maximum of 99 hours and 59 minutes and will then remain at that display. This may help A) identify the problem and B) make a better decision on whether the charge status will need to be reset or whether Smartgauge™ will have already re-synchronized itself.

There is no need to reset any other functions. Smartgauge™ will remember all settings (with the exception that status alarms will have been disabled). Refer to the flow chart headed “Re power up following power failure” for details of the expected display at the back of the manual.

Note that re powering up Smartgauge™ results in a completely different display from when it is first powered up following first installation (or following a reset to factory defaults). In particular it does not carry out the System Check (“SC”) and does not ask for the battery type. Both these parameters are stored in non-volatile memory and will be retained from the previous use. Also note that following re-application of power Smartgauge™ will continue to operate as previously so, given time, it will successfully re-calibrate the charge status of the batteries.

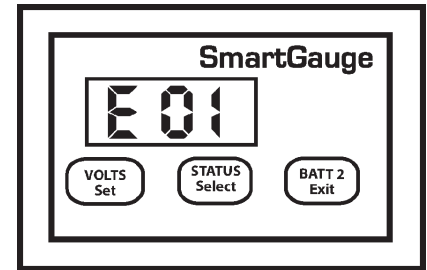

Note that previously set Status alarm will now be switched off. If for some reason it is required to revert the unit to “as new” status, prior to first installation (perhaps the unit is being moved to a new installation) then refer to Section 6.0.

SECTION 4.0 – BASIC MONITOR USE

Pressing the VOLTS button will display house battery voltage. Pressing the STATUS button will display charge status of the house battery bank. Pressing the BATT 2 button will show the voltage on the engine starting battery and the PGM/ Batt 2 LED will light up to indicate that engine battery voltage is currently being displayed. To return to house battery bank display, press VOLTS or STATUS.

If no buttons are activated for two minutes, the display will go into sleep mode. This is a power saving feature. Smartgauge™ will continue to operate, calculating the charge status and monitoring for error conditions, alarms etc. Pressing any button will bring Smartgauge™ out of sleep mode and the display will operate for an additional two minutes. Sleep mode may be defeated if required (refer to “Display Modes” at the back of the manual).

If the battery voltage goes outside the measurement range (>17 volts or <9 volts for 12-volt systems) or (>34 volts or <18 for 24-volt systems), the volts display will show “HI” or “LO” while the voltage remains outside of range. An “E04” error will also be displayed and will remain displayed to alert the user to a problem – until a button is pressed. If the battery voltage remains below the low-voltage warning for the set battery type an “E02” error will be displayed. If the battery voltage remains above the high-voltage warning for the set battery type, an “E03” error will be displayed.

The high and low voltage warnings described above are outside the preset limits which vary for each battery type. “HI” or “LO” voltage displays should be responded to promptly, as battery damage or other dangerous conditions may be responsible for the alerts. If power is lost an “E01” error will be displayed.

“HI” and “LO” error displays are only shown if the display is currently set to “Volts”. They are not displayed if the display is set to “Status”. They are also not shown if the display has gone into sleep mode. But the resulting error message will remain displayed. All error codes are displayed regardless of monitor mode. They are shown even if the display has gone into sleep mode.

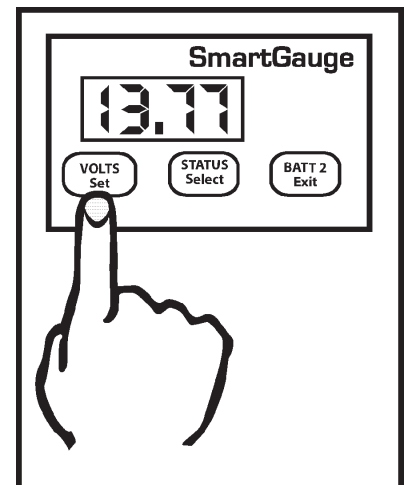

The Smartgauge™ set-up menu allows the user to set and adjust a variety of the monitor's features:

To enter the set-up menu press both the VOLTS and STATUS buttons simultaneously and keep them pressed. After 2 seconds the display will change to "bt x" (battery type x).

When in the set-up menu, the PGM/Batt 2 LED will flash.

During set-up mode, all internal calculations stop. For this reason there is a time limit on the set-up menu. Each item to be set will allow approximately two minutes for the user to set the function. After two minutes elapse, the currently displayed selection will be written to Smartgauge™ memory and the set-up menu will be exited. Smartgauge™ will then revert to normal operation. When in the set-up menu, the main legends on the buttons are no longer active. Instead the secondary legends are the appropriate functions. The secondary legends are in blue smaller letters underneath the main legends.

Pressing the SELECT button will scroll the current displayed value or option to the next available one. At the last value, Smartgauge™ will cycle to the first value and continue. Pressing the SELECT button will simply scroll round and round all available values indefinitely. Pressing the SET button will set the displayed value. When the value has been selected, the display will flash 4 times to indicate the value has been written to memory. The display will then move on to the next menu item.

Pressing the EXIT button does the same as pressing the SET button except that after writing the value to memory, it exits the set-up menu instead of moving on to the next item.

At any time, when moving onto a new menu item, the existing value (be it alarm voltage set points, battery types, display modes etc) will be displayed first. Pressing the SET button will show each selected item without ever changing any of them. This allows you to look through the menu to check all the settings without changing any of them or having to remember what they should be set to.

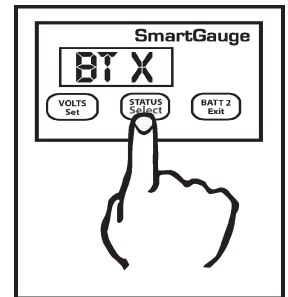
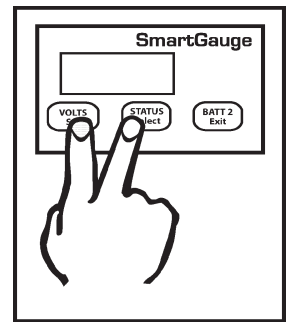

SECTION 4.2 – SET UP MODE – BATTERY TYPE

When entering the set-up menu, the programming mode is the battery type, shown as "bt x" where "bt" signifies battery type and "x" shows the current selected type. If this is a first power up, "x" will be 1. Otherwise it will show whatever setting is the currently selected battery type. If you are unable to identify your battery technology, please contact your battery supplier for advice.

The battery types are numbered 1 to 7 and are as follows:

- Type 1 Standard wet cell deep cycle Lead Acid - Use this setting for:-
 1. Standard vented Lead Acid deep cycle
 2. Lead acid recombinant (have a catalyzer in the cap to recombine the oxygen and hydrogen back into water that is normally lost during charging in a standard Lead Acid battery). Do not confuse with VRLA (AGM or Gel).
- Type 2 Gel Cell – Use this setting only for Gel Cells
- Type 3 AGM - Absorbed Glass Matt (VRLA)
 1. Use only for genuine AGM batteries. NOTE: There are two very distinct types of AGM batteries with very different operational characteristics. In one type the only real difference is that the electrolyte is held in a glass matt. This type usually have charge voltages very similar to flooded wet cell batteries. The off load terminal voltages will also be very similar to flooded wet cell batteries. If your AGM batteries are of this type then Smartgauge™ should be set to battery type 1.
 2. The other type of AGM have additional chemicals in the battery and require lower charge voltages and the off load terminal voltages will be similar to gel cells. This type require Smartgauge to be set to battery type 3.

- Type 4 – HYBRID (Also known as Antimony/Calcium or Hi-Calcium.)
 1. Usually identified by being sealed but the acid inside the battery is still liquid. Many are fitted with a ‘magic eye’ to give an approximate indication of battery condition. Usually marked maintenance free and its normally not possible to open the top of the battery.
- Type 5 – Carbon Fiber
 1. Lead/Acid batteries with Carbon Fiber additives to the plates.
- Type 6 – Maintenance free, Calcium/Calcium.
 1. Marketed as a semi-traction battery.
- Type 7 – Custom Program
 2. Do not select type 7 unless your Smartgauge™ has been supplied with a specific battery program. Type 7 only appears on the set-up menu after the initial power up sequence.

SECTION 4.3 – SET UP MODE – CHARGE STATUS

Charge status can be manually set to any value between 0 and 100%. Enter the set-up menu as usual, then press the SET key until “Cxxx” is displayed. “C” signifies charge status. The xxx displayed will be the current calculated charge status. Pressing the SELECT button will scroll up to and including 100 then cycle to zero and start again. When the desired value is displayed, press the VOLTS key. The display will flash to show the value has been stored. The display will then move onto the next menu item.

Alternatively, pressing the EXIT button will write the value to memory then exit the set-up menu.

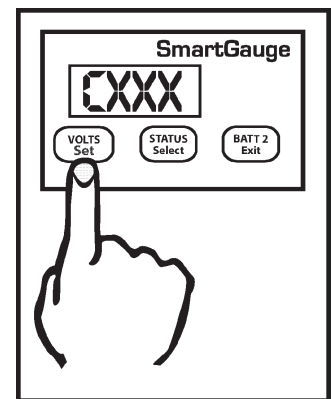

SECTION 4.4 – SET UP MODE – ALARM FUNCTIONS

There are two levels of alarm settings in Smartgauge™. The first is the Primary Alarm which can be set OFF or can be used to access low/high voltage or low SoC function. See Section 7.0 for information regarding alarm outputs.

Primary Alarm:

On entering this section of the set-up menu the display will show “PA x”. PA signifying Primary Alarm. “x” displaying either “O” “U” “S”. or “t”. “O” means alarms are switched Off.

“U” means Uoltage (Voltage) alarm is enabled, “S” means low Status alarm is enabled. “t” means a timed low status alarm is enabled. “S” and “t” type alarms are more fully described under their respective headings. The SELECT button will scroll round them. The SET button will set the desired alarm. The display will flash showing the value was written to memory. Changing the alarm type will cancel any currently active alarms and reset the timed alarm timers to the user’s programmed default value.

On selecting “PA O” the display will flash and then move onto the next item in the set-up menu, Secondary Alarm.

Individual Alarm Selection:

Set-up mode – Voltage Alarm:

1. On selecting “PA U” the display will flash to show the value was written to memory. The display will then show either “Hi” or “Lo”. The SELECT button will alternate between these two options. “Hi” sets a high-voltage alarm. “Lo” sets a low-voltage alarm. Pressing SET will store the value.
2. The display will then show “xx.xx” which is the lower voltage trip point. Once this is set (using the SELECT and SET buttons) the display will again show “xx.xx” which is the upper voltage trip point.

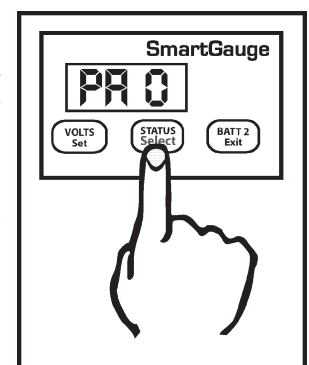
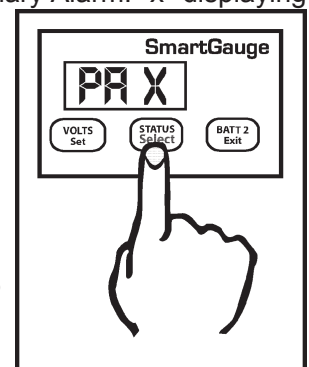

If a low voltage alarm was set, the lower voltage trip point is the voltage below which the actual battery voltage will have to fall in order to trigger (activate) the alarm output. This is the activation voltage. The factory default for this value is 11.80 volts. Pressing the SELECT button will scroll this value up to and including 16.50 volts. It will then cycle to 10.50 volts then continue to scroll upwards. When the desired value is displayed, press the SET button to write the value to memory, the display will flash. The upper voltage trip point is the voltage which the actual battery voltage will have to rise to in order to deactivate the alarm. This is the deactivation voltage. The factory default for this is 13.20 volts. Pressing the Select button will scroll this value up to 16.50 volts, it will then wrap round to whatever value was previously entered for the alarm activation voltage. This means that no matter what you do, Smartgauge™ will not allow this value to be set lower than the activation voltage.

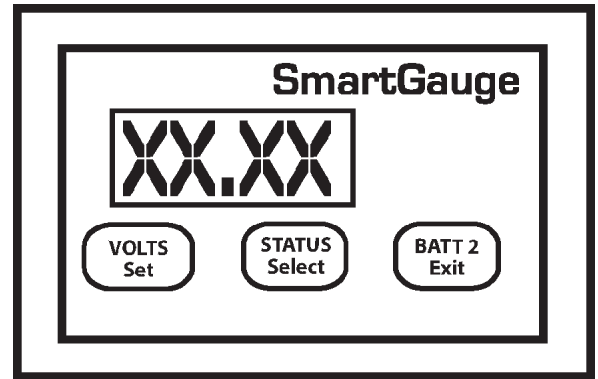

Pressing the SET button will write the value to memory. If a high voltage alarm was set then the procedure remains identical except the upper voltage trip point is the voltage which the battery voltage will have to rise to in order to activate the alarm. Once the alarm is triggered, the battery voltage will have to fall back down below the lower voltage trip point in order to deactivate the alarm.

The display will then move on to the next item in the set-up menu, secondary alarms. Remember, at any time in the set-up menu, pressing the EXIT button will write the current value to memory then exit the set-up menu.

Clarification – For a low voltage alarm:

1. The battery voltage has to fall below the activation voltage to trigger the alarm.
2. The battery voltage has to rise to the deactivation voltage to kill the alarm.

So if the activation voltage is set to 12.00 volts then the battery voltage will have to fall to 11.99 volts to trigger the alarm. If the deactivation voltage is set to 12.80 volts then the battery voltage will have to rise to 12.80 to cancel the alarm. Although the battery voltage is displayed to a resolution of 0.05 volts (0.1 volts in 24 volt systems), internally it is measured and dealt with to a finer resolution.

While 16.50 volts may seem very high for a maximum low voltage setting, this does allow the low voltage alarm to be used for two extra functions. One is as a “charger failure” alarm, the other is to enable the feature to be used to auto-start a generator set feeding a constant current type battery charger and shutting the generator down at the correct time.

For a high voltage alarm:-

1. The battery voltage has to rise to the deactivation voltage to trigger the alarm.
2. The battery voltage has to fall below the activation voltage to kill the alarm.

Status Alarm

There are two types of Low-Status alarms. The first is exactly the same as the low-voltage alarm but operates on charge status instead of on battery voltage. So the alarm will activate once the charge status falls below the chosen activation status, and will deactivate after the charge status rises back up to the chosen deactivation status. This type is designated in the display as “PA S”

The “PA S” type alarm is set in exactly the same way as the “PA U” alarm except “PA S” is selected instead of “PA U”. i.e. the activation status will be set, followed by the deactivation status.

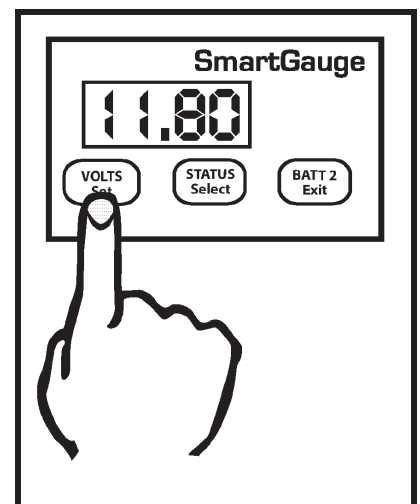
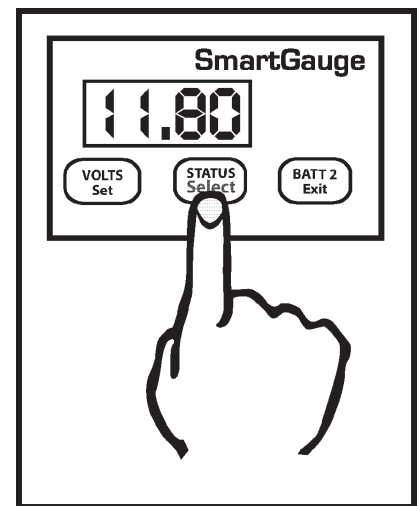

Clarification:

1. The SoC% has to fall below the activation status to trigger the alarm.
2. The SoC% has to rise to the deactivation status to kill the alarm. The range limits are:
 1. Activation status = 1 to 75%
 2. Deactivation status = activation status to 100%

Factory defaults are activation status = 50%, deactivation status = 95%. These would be typical figures used for an auto start gen-set (See Note 2 in addendum for additional information).

The “PA t” alarm is slightly different. If this alarm is set, the alarm will trigger (be activated) once the charge status falls below the activation status. The alarm will remain triggered until the status rises back up to the same activation level but then, once this happens, a timer is started which counts down from the set time period, and when it reaches zero, the alarm is deactivated. The main reason for this type of alarm is to enable an auto start generator set to be started once the charge status falls to a certain level and then run for a certain fixed period (see Note 2 in addendum).

On selecting “PA t” the display will flash to show the value was written to memory. The display will then show “xx” which is the charge status below which the actual battery charge status will have to fall in order to trigger (activate) the alarm output. This is the activation status. The factory default for this value is 50%. Pressing the SELECT button will scroll this value up to and including 75%. It will then cycle to 1 and continue to scroll upwards. When the desired value is displayed, press the SET button to write the value to memory, the display will flash as usual. The activation status is now set. Note that this activation status shares the same memory as that used for the normal low status alarm. So changing one, will change the other.

The display will now show “tx.xx”, indicating the time, in hours and minutes, that the alarm will remain activated. The default is 4 hours. However, if an alarm of this type is actually active when you enter the set-up menu (i.e. the alarm LED is on), then this figure will be the current time remaining, on the current countdown timer, rounded to the nearest 15 minutes. This enables the user to increase or decrease the remaining time for an existing alarm timer run.

Pressing the SELECT button will increase this time in steps of 15 minutes up to a maximum of 9 hours and 45 minutes and cycle back to 15 minutes. Once the desired time is reached, pressing the SET button will, as usual, cause the display to flash, the value will be written to memory and the display will move on to the next item in the set-up menu.

If an alarm is not active at the time you enter the set-up menu then this time period will become the default time period for all future status timed alarms. Remember, changing alarm type will cancel any currently active alarms. If this menu item is entered while a timed alarm run is active and it shows the time remaining on the current run (as opposed to your default run time), only the time remaining on the current run will be affected.

The normal full time for a timed alarm run will not be changed and will remain as you last set it (or at the factory default if no changes have been made). It is not possible to change the default run time whilst a timed alarm run is active. Note that this timed period is approximate. The timed period and the display will be accurate to within about 10% Also note that internally Smartgauge™ counts in seconds whereas the display only shows the minutes. It is rounded to the nearest minute so when the display counts down and reaches zero, there could in fact be 30 seconds remaining.

Set-up mode - Alarms – General

Once an alarm is triggered, the alarm output will activate. The Alarm LED on the front panel will illuminate and the display will alternate between its current display (for 3 seconds) and the alarm display (for 1 second). The

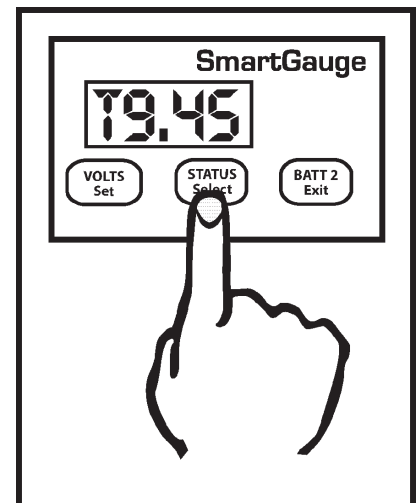
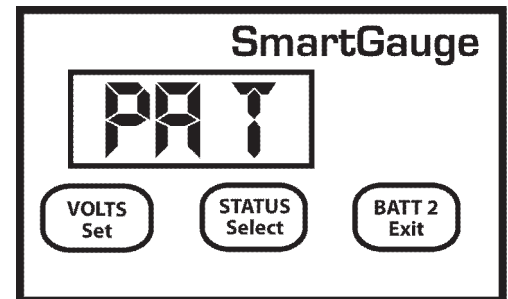

alarm display will either show “A LU” for Alarm Low Voltage, “A HU” for Alarm High Voltage or “A LS” for Alarm Low Status. If “PA t” has been set, then when the alarm triggers, the display will alternate in 2 ways. It will show the current display (3 seconds), then it will show “A Lt” (Alarm Low status timed),(1 second), it will then revert to the normal display (3 seconds), it will then show the time in hours and minutes until the alarm is due to deactivate (for 1 second). For 9 hours 45 minutes, the display would show “t9.45”. Note that when the display reaches 0.00 there could actually be up to 30 seconds remaining. This is because the timer does not display the seconds.

Changing the alarm type will cancel any currently active alarms. Alarm set points and timers can be changed, and the existing alarm will remain active. But actually changing the alarm type (such as from low voltage to low status) will cancel the currently active alarm. This is a simple way of cancelling an active alarm. If the display is in sleep mode then the alarm output will still activate but the alarm status display will not show, however the Alarm LED on the front panel will still light up. Pressing either button will show what type of alarm has activated in case you forget which type you set. And in the case of “PA t” will show the time remaining before deactivation.

Set-up mode - Secondary Alarm

The secondary alarm activates the alarm output, which can drive an external audible warning device or warning light in an error code event. The display will show “SA x”, “SA” signifying Secondary Alarm, “x” showing the current setting. The default is “O”, Off. “x” can be set to any of the following:- O Off Default. Error codes will never activate the alarm output.

U Voltage Error codes E 02 and E 03 (low- or high-voltage warnings for selected battery type) will activate the alarm output. Note that if error codes are disabled (the next function in the set-up menu) this secondary alarm will not operate. Range Error code “E04” (measurement range error) will activate the alarm output. Power lost Error code “E01” (Power lost) will activate the alarm output. Note that if any error codes are disabled (the next function in the set-up menu) then the disabled error codes will not activate this alarm.

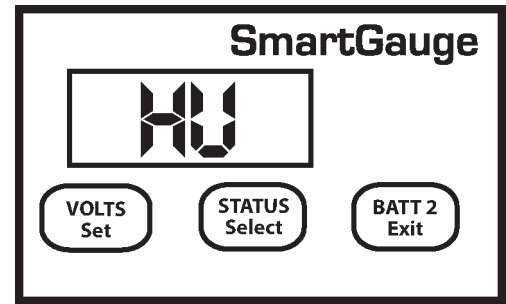

Indicates Alarm – High Voltage

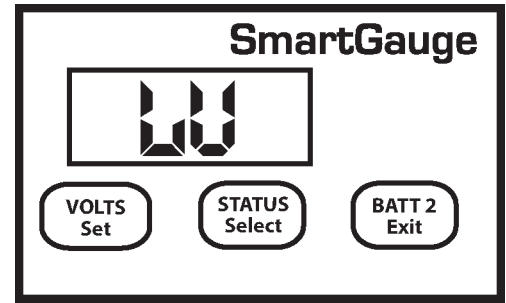

Indicates Alarm – Low Voltage

SECTION 4.5 – SET UP MODE – DEFEATING ERROR CODES

In some circumstances, it may be necessary to defeat the error code functions in Smartgauge™. Most installations, particularly those where loads are used at the same time as charging, use what are known as 2 or 3 stage chargers. These chargers use a combination of an initial (the first stage) “constant current” charge cycle (usually referred to as the bulk stage) then switch to a second stage of constant voltage (usually referred to as the acceptance or absorption cycle). Three stage chargers then switch to a third cycle known as “float”. These types of chargers usually keep to within very well accepted voltage limits during the charge cycle.

Certain constant voltage chargers may provide a very high charge voltage of around 16 volts or more for a short period of time which can trigger repetitive or continual E 03 error codes in Smartgauge™. For this reason the next setting on the set-up menu allows error codes E 02 and E 03 to be defeated. The display will show “EC x” signifying Error Codes and “x” being either “1” for error codes enabled (the default) or “O” for error codes disabled. Note that this setting only affects error codes E 02 and E 03. The other error codes will continue to operate. Note that error code E 02 is a low voltage warning code. The reason this code is also disabled is that users of the types of chargers that may trigger the E 03 error code are usually experienced users who are aware of how far they can push batteries in order to get the maximum usage from them.

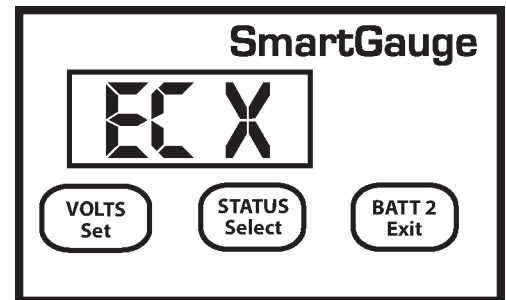

If the “Secondary Alarm” function has been set to activate the alarm on E 02 or E 03, or set to activate the alarm on all error codes, and E 02 and E 03 have been disabled then they will no longer trigger the alarm. The remaining error codes will still activate the alarm as programmed.

SECTION 4.6 – SET UP MODE – DISPLAY BEHAVIOR

There are three display modes available in the Smartgauge™. The modes apply whether the display is showing volts or charge status.

The default factory setting displays for 2 minutes before going into sleep mode. This mode is signified in the set-up menu as “dt t” meaning display type = timed. This display will remain active for 2 minutes following a button press. It will then go back to sleep. Pressing a button will switch the display back on for another 2 minutes.

The second display mode is “dt A” meaning “display type = Always” where the display will always be on and will never go into sleep mode.

The third display mode is “dt U” meaning “display type = Voltage” where the display will go into sleep mode, after 2 minutes, as usual, below a certain voltage but will always remain on above a certain voltage. This voltage is actually the upper voltage trip point for the high/low voltage alarm. The factory default setting for this is 13.20 volts (26.40 volts on 24 volt systems). So if this display mode (“dt U”) is selected and the alarm factory defaults have not been adjusted, the display will blank as normal after 2 minutes if the battery voltage is below this level but will always be on above this voltage. This makes sense in so far as if the battery voltage is above this level then clearly the batteries are either being charged or they are well charged and in either case the extra few milliamps of power consumed is not an issue. It also allows a keen eye to keep watch on the battery charge voltage without having to continually press buttons. But when the charger is switched off Smartgauge™ will revert to the minimum required current draw by blanking the display 2 minutes later.

Note that whilst this setting uses the upper deactivation voltage level of the low voltage alarm, the low voltage alarm does not have to be enabled or active for this function to operate. The two functions merely share the same value.

To select the display mode, enter the set-up menu as usual, then press the VOLTS button until “dt x” is displayed. “dt” signifying display type, the x showing either t, A or U. Now press the STATUS button to scroll through the three or four values. Press VOLTS to confirm the choice. The display will flash to show the value has been written to memory. The display will then move onto the next menu item.

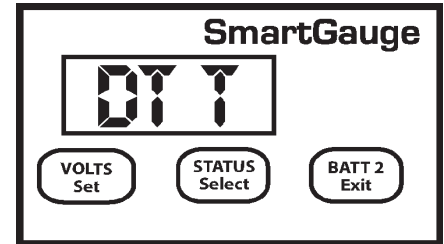

Signifies Timed Display Mode

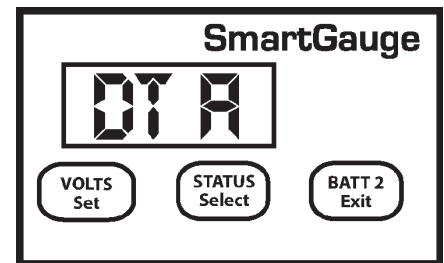

Signifies “Always” Display Mode

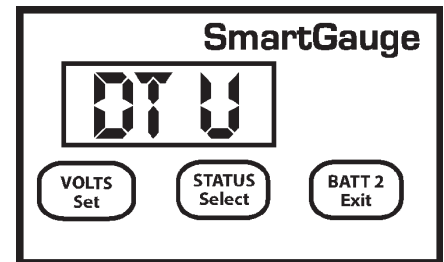

Signifies “Voltage” Display Mode

SECTION 4.7 – SET UP MODE – DISPLAY BRIGHTNESS

The display brightness is fully adjustable to enable the Smartgauge™ to be used in any light conditions. One of the advantages of this type of display (LED – Light Emitting Diode) as opposed to the other common display (LCD – Liquid Crystal Display) is that they can be read in zero light conditions as well as daylight. To adjust the display brightness enter the set-up menu, then press the VOLTS key until “db x” is displayed. “db” signifies display brightness, x indicates the current brightness which will be from 1 to 8. The factory default value is 4. Pressing the STATUS button will scroll through the values, cycling to 1 when 8 is reached. You will see the brightness change as you scroll through the values. When you find the brightness level that best suits your environment, press the VOLTS button. The display will flash to show the value has been stored then Smartgauge™ will move on to the final item in the set-up menu.

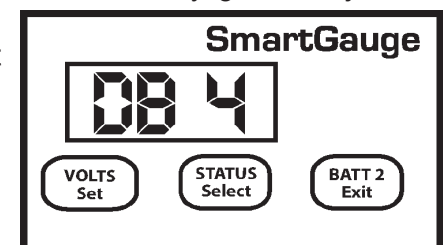

Signifies Default Brightness

The last item in the set-up menu will display Loc0. This allows access to the set-up menu to be denied.

Pressing STATUS will alternate between Loc0 (meaning lock is disabled) and Loc1 (meaning lock is enabled). Setting Loc0 will allow Smartgauge to continue to operate exactly as before. Setting Loc1 will prevent future access to the set-up menu. All other functions of Smartgauge remain identical. If Loc1 is set, then any future attempts to enter the set-up menu will be completely ignored. In order to unlock Smartgauge™ it will be necessary to attempt to perform a “reset to factory defaults”.

If the lock is disabled (Loc0), then “reset to factory defaults” will operate as usual. If the lock is enabled (Loc1) then attempting to perform a “reset to factory defaults” will not do so. It will simply unlock the unit to, once again, allow access to the set-up menu.

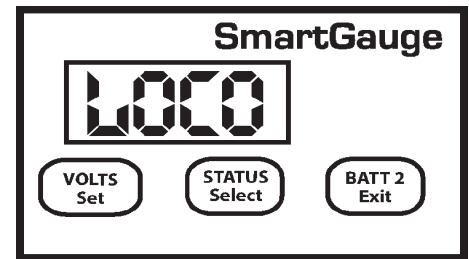

Signifies Menu Lock Disabled

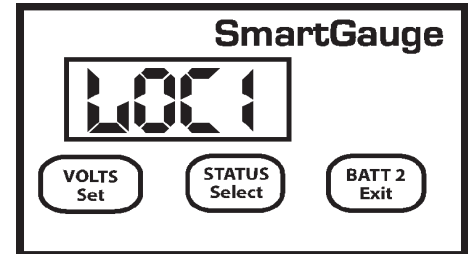

Signifies Menu Lock Enabled

SECTION 5.0 – ERROR CODES

Error codes do not indicate a problem with Smartgauge™. They indicate a problem with the installation or other equipment such as chargers. For instance, a continual “E03” error signifies a charger fault, not a Smartgauge™ fault.

With all “Exx” type error codes, the code is displayed alternately with the current display. If the display has gone into sleep mode, the error code will still be displayed. This is to ensure that an error does not go unnoticed.

The error code will continue to be displayed after the fault condition that caused the error has cleared. This means that if, for instance, the charger is intermittently faulty, and occasionally charging at a much higher voltage than it should be, this would force an error “E03” which would remain in the display even after the charger had gone back to functioning correctly. In order to clear the error code simply press any button.

If another error occurs while an earlier error is displayed, the new error code will take precedence. The exception to this is the unique case of an “E01” (lost power) error. This error takes precedence over all other errors.

“E01” – Power was lost and reapplied.

If power to the Smartgauge is lost, the Smartgauge™ has no way to determine the duration of power loss. Therefore, the “E01” may indicate that the charge status may be incorrect and that any primary status alarms will have been disabled. Alarm set points will still be as they were last set but the actual alarm will be switched off and will remain so until re-enabled by the user. Any low voltage alarms or secondary alarms will remain set as they were prior to the power loss.

Pressing any button will clear the “E01” error code. The display will then show the time in hours and minutes since power was reapplied (up to a maximum of 99 hours, 59 minutes). Pressing any button will clear this display. If no button is pressed, the display will time out after 2 minutes then revert to normal operation. While showing the time since re-power, the PGM LED will flash.

As with all errors, using the Secondary Alarm function described in the section regarding the set-up menu it is possible to set the “E01” error to trigger the alarm output, perhaps to sound an audible alarm or light up a warning light.

“E02” – Battery voltage has been below acceptable level for battery type.

Each battery type has certain voltage and time limits, which, if exceeded, may damage the batteries.

For instance if a deep-cycle lead acid battery experiences a terminal voltage lower than 10.2 volts for any appreciable length of time it may cause serious, immediate, permanent damage to the battery. Smartgauge™ has different voltage and time limits for each battery type. If this limit is exceeded then Smartgauge™ will generate an “E02” error. This error will alert the user to the problem. Be

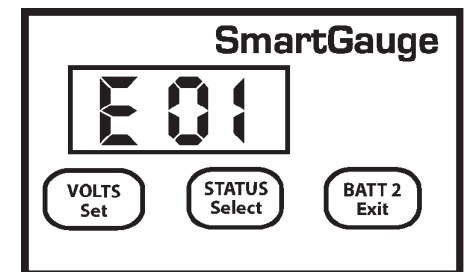

Indicates Power Lost & Reapplied

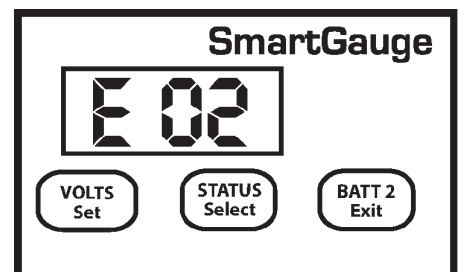

Indicates Low Battery Voltage

aware that if this error code occurs it is an indication of a sever problem in the installation that, if allowed to persist, will eventually destroy the batteries. Note that this error means the voltage and time limits have been outside of range since a button was last pressed. It does not mean they are currently being exceeded. The error is stored after the fault has cleared until the error is cleared by pressing a button.

“E03” – Battery voltage has been above acceptable level for battery type.

This is similar to “E02” but for high voltage. The voltage level and time limits vary dependent upon battery type. For example a wet cell antimony/antimony battery is far more tolerant of high voltage levels than Gel cells and AGM types. Wet cell calcium batteries are even more tolerant than antimony/antimony. Wet cell batteries can tolerate 15 volts or more for long periods of time (always assuming the production of explosive gasses is dealt with) whereas even 14.6 volts could severely damage Gel cell or AGM batteries in a very short time.

This error means the voltage and time limits have been exceeded since the last error was cleared. It does not mean they are currently being exceeded. The error is stored after the fault has cleared until the error is cleared by pressing a button. Error codes E 02 and E 03 can be disabled by the user. Refer to Section 4.5 for instructions.

“E04” – Battery voltage has been above acceptable level for battery type.

SmartGauge™ can accurately measure voltages between 9.00 and 17.00 volts in 12 volt mode and between 18.00 and 34.00 volts in 24 volt mode. If these limits are exceeded SmartGauge™ has no way of measuring the actual voltage. Also, if these limits are exceeded there is something seriously wrong with the installation. Such extreme voltages simply should not arise and indicates a serious problem with the charging system.

HI Battery voltage is above upper measurement limit of 17.00 volts (34.00 volts in 24 volt installations).

LO Battery voltage is below lower measurement limit of 9.00 volts (18.00 volts in 24 volt installations). Note that Hi and LO errors will clear as soon as the voltage returns to within the measurement range. They will, however, leave an “E04” error code on the display. Repeated displays of the “E04” error code may indicate a system ground error or a potential battery cell fault. The “E04” error indicates a condition which should be addressed by a qualified electrician.

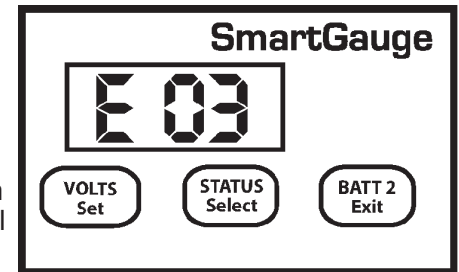

Indicates High Battery Voltage

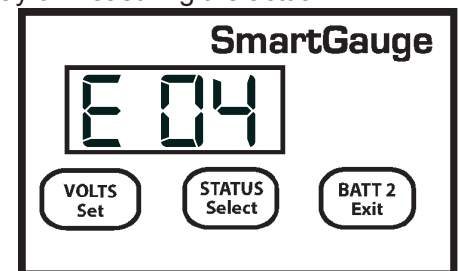

Indicates High Battery Voltage

SECTION 6.0 – RESET TO FACTORY DEFAULT

Circumstances™ such as change of battery technology, or the need to override a menu lock, require that you return the Smartgauge™ to its Factory Default state. To return the monitor to its default settings:

1. Disconnect the power feed to Smartgauge™ (pull the fuses in each feed wire out).
2. Press both the VOLTS and STATUS buttons and keep them pressed.
3. Reapply power, still keeping the buttons pressed.
4. Smartgauge™ will display the software revision as usual. Keep the buttons pressed.
5. Smartgauge™ will display the battery model revision as usual. Keep the buttons pressed.
6. The display will go blank.
7. Remove your fingers from the buttons.
8. Smartgauge™ will flash “Fr” (Factory reset).
9. Smartgauge™ will completely reset its internals to the factory defaults.

Smartgauge™ will now operate exactly like a new unit on first power up beginning by displaying the software revision. NOTE – If the set-up menu lock had been set prior to this, then attempting to perform a “reset to factory defaults” will not do so on the first attempt. It will simply disable the menu lock. A second attempt will perform the reset to factory defaults.

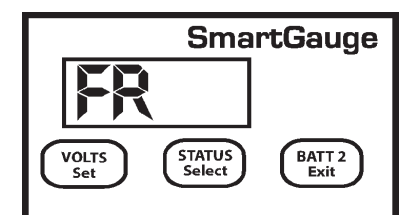
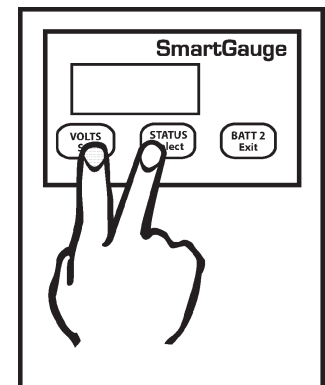

Indicates Reset To Factory Default

1. The alarm output consists of 3 terminals labelled COM (Common), NC (Normally Closed) and NO (Normally Open). COM is connected internally via a relay to the NC terminal and disconnected from the NO terminal. When an alarm is activated the COM terminal is internally connected to the NO terminal and disconnected from the NC terminal. At no time are NC and NO terminals connected together (break before make).

These three terminals are totally isolated from the rest of Smartgauge™ which means you can use them for more or less anything within the following constraints:

1. The maximum voltage between any of the three terminals and/or the DC system to which Smartgauge™ is connected is 48 volts. Exceeding this voltage may damage Smartgauge™, and will invalidate warranty.
2. The maximum permissible current to be carried by the alarm terminals is 500mA (0.5 amps). Exceeding this current may damage Smartgauge and invalidates the warranty.

If either of these need to be exceeded then use the alarm output to operate an external relay with the required specifications.

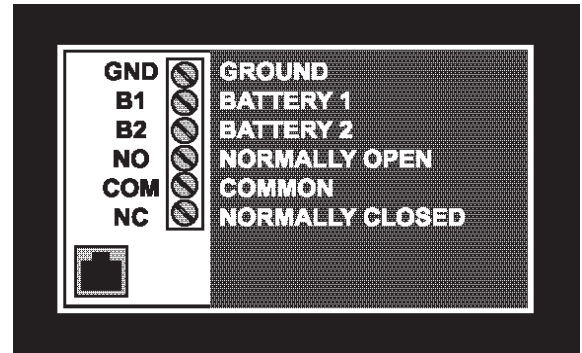

SECTION 8.0 – ALARM NOTES

Assuming the low voltage alarm has been enabled it operates as follows:

1. Assume the low voltage activation setting is set to 12.00 volts and the deactivation setting is set to 13.20 volts. The battery voltage is at 12.6 volts. The alarm output is not active. COM is connected to NC. NO is not connected to anything. The alarm LED is unlit.
2. As the battery voltage falls eventually it will reach 12.00 volts. The alarm output remains as above. When the battery voltage falls to 11.99 volts (i.e. below the activation level) the alarm output will activate. COM is now connected to NO. NC is not connected to anything. The alarm LED will light up. An audible alert connected to the batteries via COM and NO will now beep.
3. As the voltage rises to say 12.80 volts the alarm output remains in this state. The battery voltage rises to 13.20 volts, the alarm output deactivates, COM is once again connected to NC and NO is connected to nothing. The alarm LED will go off again. The sounder will go silent. Operation of the standard low status alarm is identical to that of the low voltage alarm except, of course, that it operates on the charge status as opposed to the battery voltage. Timed low status operates slightly differently. (See Section 9.0 Addendum.)

SECTION 9.0 – ADDENDUM

Charge Status during charging and discharging

During discharge, the Smartgauge™ accurately tracks the State of Charge of the batteries. When the opportunity arises, the Smartgauge™ polls the battery voltage and uses the results of this measurement to compare with its calculated figures for charge status. Smartgauge™ uses this information to adjust its battery model and the Smartgauge™ algorithm so that future discharge cycles become more and more accurate. This is one of the ways in which Smartgauge™ automatically adjusts itself to compensate for battery aging and the consequent reduced battery capacity as they get older. This is also one of the ways in which Smartgauge™ is superior to a meter based on the amp hours counting principle. This is a continual process that continues throughout the life of the batteries so that Smartgauge™ always shows the percentage power remaining as a fraction of the actual currently available battery capacity, as opposed to a percentage of what used to be available when the batteries were new.

Discharging is the important phase, as this is when one really needs to know the State of Charge. During charging this is not possible due to the presence of the charger preventing Smartgauge™ ever getting an opportunity to actually measure the charge status. In effect, if it tried, it would be attempting to measure the charge status of the charger. During charging, Smartgauge™ only shows the calculated charge status as does an amp hours counter. However Smartgauge™, because it operates on a different principle, calculates a charge status that is

much more accurate. For this reason, it is possible that, during the charge cycle, the charge status displayed may not be totally accurate. It will be within 10% of the actual battery charge status.

(Note that once discharging commences, Smartgauge™ will automatically re-synchronize itself within the first few minutes of discharge or within the first 10 minutes of resting if no load is present. Smartgauge™ uses this information to modify its battery models and algorithm to increase the accuracy of future calculations)

Smartgauge™ will provide a dependable indication (certainly better than an amp hours counter – and certainly better than a volt meter but it could be that Smartgauge™ shows the charge status to have reached (as a worst case example) 100% when in actual fact the batteries have only reached 90%.

Not charging to 100% charge state is one of the most common reasons for premature battery failure. Not charging to 100% (or occasionally well in excess of 100%) causes sulfation of the plates which is the main cause of early battery failure. Therefore, as when using any form of charge status meter, and if using an intelligent charger, do not shut the charger down when Smartgauge™ indicates 100% SoC. Instead, rely upon the charger, which can reach a much more accurate measurement of when the batteries are actually fully charged.

Also consider the possible results of using the Primary Alarm set to operate on charge status. If this is being used to operate an auto start generator and charger, and the generator is regularly shut down before reaching 100% charge status this, again, will cause the plates to sulfate.

This is the reason for the option to set the low status alarm to operate for a fixed period of time instead of until reaching a certain charge status. In some installations it may be better to use this option to ensure that the generator is run for a sufficient period of time. Either way, once discharging commences, Smartgauge™ will re-synchronize itself (whatever the final true charge status that was reached – i.e. it will not simply assume 100% charge status, as many amp-hours counters do) and then give a true indication of the charge status throughout the discharge cycle.

Conversely, it may be the case that the Smartgauge only reaches 90% charge status during the charge cycle when in actual fact the batteries have reached 100% charge status and the intelligent charger has gone into float charge. If this happens, again Smartgauge™ will re-synchronize itself during the first stage of the discharge cycle.

Whatever happens, whenever Smartgauge™ “gets it wrong”, Smartgauge™ realizes, corrects itself, and uses the information to modify its battery models and algorithm. An amp-hours counter simply “gets it wrong”, and does nothing about it, and runs further and further adrift from the true State of Charge.

Smartgauge™ will NOT run out of synchronization with the batteries.

SECTION 10.0 - SPECIFICATIONS

Smartgauge™ Specifications		
Balmar Part Number		44-SG-12/24
Supply Voltage Range		8-40V DC
Current User Requirements	Sleep Mode	5mA
	Work Mode	<15mA
Operating Temperature Range		-23°F to 150°F
Monitor Accuracy	State of Charge	+/- 5%
	Voltage	+/- 3%
Dimensions		4.4" x 3.0" x 1.0"
Dash Opening		3.8" x 2.5"
Ship Weight		1.7 Lb.
Standards Compliance		CE, ISO 7637-2

Smartgauge™ is warranted to be free of workmanship defects for a period of 2 years. In the event of a warranty claim, please contact Balmar Customer Service at +1-360-435-6100 for a return authorization.

Exclusions to this warranty include:

1. Opening the case.
2. Any form of external damage to the case such as drilled holes (excluding the 4 pre-drilled mounting holes) etc.
3. Use of the equipment in any manner not described in this owner’s manual.
4. Attempted modifications.
5. Excess voltage or current as a result of incorrect installation.
6. Exceeding the rating of the alarm outputs.
7. Attempting to plug any non-approved equipment into the Smart interface state of chargeket or using the incorrect type of communications lead.
8. Incorrect installation.

Visit www.balmar.net for more information regarding Balmar warranty policies and procedures.

SECTION 12.0 – SMARTGAUGE FLOW CHARTS

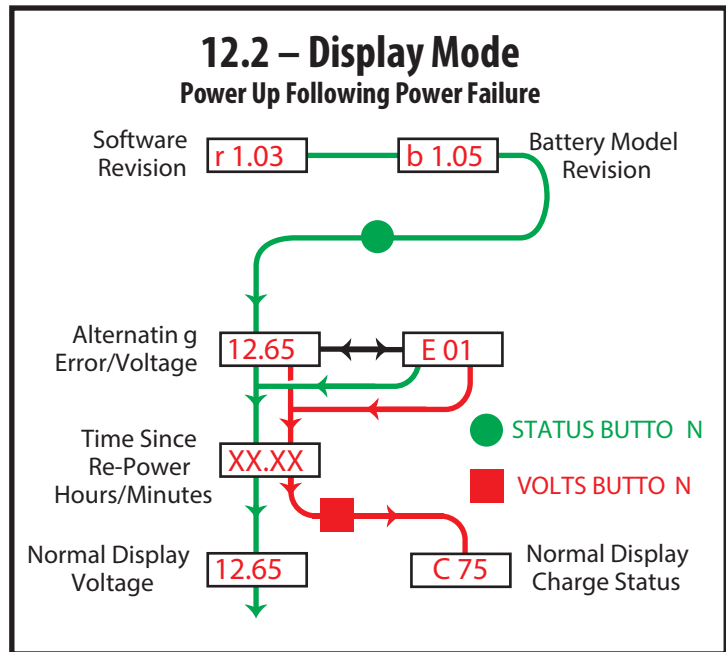
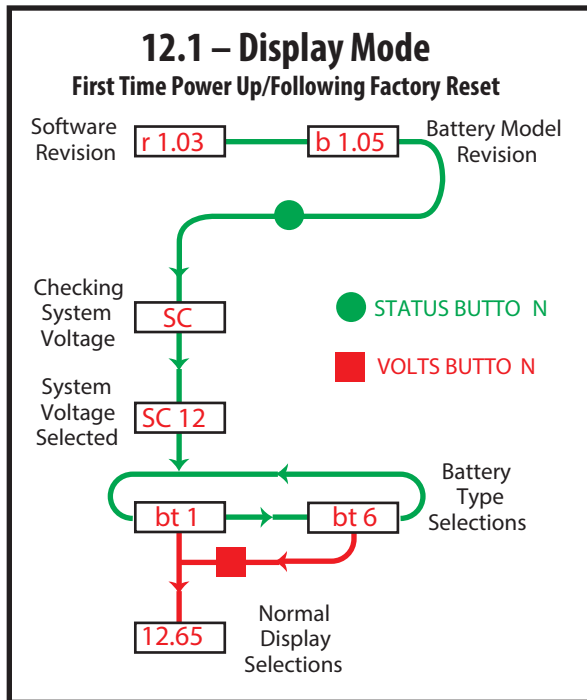

12.3 – Set Up Menu

